

PathFindIR™



PathFindIR™
Aftermarket User Manual

334-0001-00-10, version 120
April 2008

 **FLIR™**

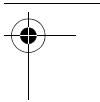
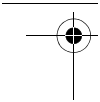
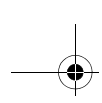
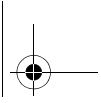

© FLIR Systems, Inc.. All rights reserved worldwide. No parts of this manual, in whole or in part, may be copied, photocopied, translated, or transmitted to any electronic medium or machine readable form without the prior written permission of FLIR Systems, Inc.

Names and marks appearing on the products herein are either registered trademarks or trademarks of FLIR Systems, Inc. and/or its subsidiaries. All other trademarks, trade names, or company names referenced herein are used for identification only and are the property of their respective owners.

This product is protected by patents, design patents, patents pending, or design patents pending.

FLIR Systems, Inc.
70 Castilian Drive
Goleta, CA 93117

Phone: 1-877-773-FLIR (3547)

www.corebyindigo.com

www.flir.com

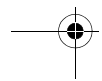
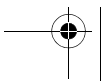
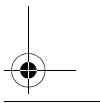
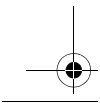

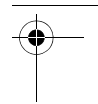
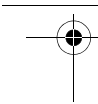
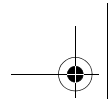
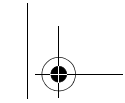

Warnings and Cautions

1

Introduction

2

Getting Started

3

Caring for your PathFindIR

4

Options and Accessories

5

Technical Data

6

Installation

7

Infrared Technology

8

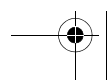
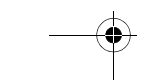
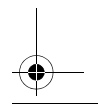
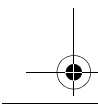

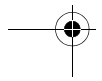
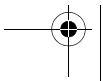
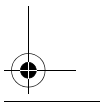
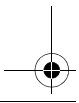
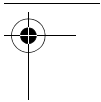
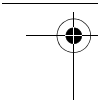
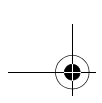
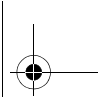



1 Warnings and Cautions

1.1 Cautions	1
1.2 General Information	2

2 Introduction

2.1 Overview	5
2.2 Thermal Imaging Driver Vision Enhancement System	5
2.3 What is Thermal Imaging?	7
2.4 Vehicles that use PathFindIR	7
2.5 Parts List	8

3 Getting Started

3.1 Using your PathFindIR	9
3.2 Initial System Startup	9
3.3 Heater Element	10
3.4 Automatic Shutter	10
3.5 In Case of Difficulty	10
3.6 Troubleshooting	11

4 Caring for your PathFindIR

4.1 Product Cleaning	13
4.2 Temperature	13
4.3 Maintenance	13

5 Options and Accessories

5.1 Accessories	15
5.1.1 PathFindIR Standard 20 foot Cable	15
5.1.2 Other Accessories	16

6 Technical Data

6.1 Performance Specification	17
6.1.1 Side View	18
6.1.2 Side View, Additional Dimensions	19
6.1.3 Front View	20

7 Installation

7.1 PathFindIR Installation	21
7.2 Preparation	21
7.3 Installation	22
7.4 Installation Guidelines and Precautions	22
7.5 Installation Assistance	23



7.6 Mounting Assistance23

8 Infrared Technology

8.1 History of Infrared25

8.2 How do Infrared Cameras Work?29



1 Warnings and Cautions

1.1 Cautions

Caution! This guide uses the term **Caution** to indicate a potentially hazardous situation, which, if not avoided, may result in injury, damage to the vehicle or PathFindIR, or other property damage.

Do not operate any function that takes your attention away from safely driving your vehicle.

Any function that requires your prolonged attention should only be performed after coming to a complete stop. Always stop the vehicle in a safe location before performing these functions. Failure to do so may result in an accident.

Consult your local and state driving regulations prior to installation.

In many states using active monitors in view of the driver is prohibited. Consult your local and state driving regulations for laws and guidelines. User assumes all risks and indemnifies the manufacturer from any liability.

Minimize display viewing while driving.

Viewing the display may distract the driver from looking ahead and may result in an accident. The PathFindIR thermal imaging system should not be used as a substitution for head lamps or head lamp assisted human vision during vehicle operation.

Use this product for mobile 12v applications.

Use for other applications may result in excess heat, fire, and equipment malfunction.

When installing the PathFindIR, do not block the vehicle's vents or radiator panels.

Doing so may result in heat buildup, equipment breakage, and/or fire.



1 – Warnings and Cautions



1.2 General Information

Caution! The PathFindIR thermal imaging system is not intended to be used as the primary navigation system. The PathFindIR should not be used as a substitution for head lamps or head lamp assisted human vision during vehicle operation. It should be used only as an aid to cautious night-time driving.

Do not open the camera body for any reason. Disassembly of the camera (including removal of the cover) can cause permanent damage and will void the warranty.

Operating the camera outside of the specified input voltage range or the specified operating temperature range can cause permanent damage.

Do not image extremely high intensity radiation sources, such as the sun, lasers, arc welders, etc.

The camera is a precision optical instrument and should not be exposed to excessive shock and/or vibration. Refer to paragraph 6.1 “Performance Specification” on page 17 for detailed environmental requirements.

Great care should be used with your camera optics. They are delicate and can be damaged by improper cleaning. Refer to Chapter 4 “Caring for your PathFindIR” on page 13.

All thermal imaging systems are subject to export control. Please contact FLIR for export compliance information concerning your application or geographic area.



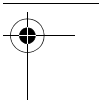
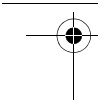
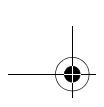
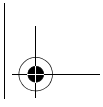

1 - Warnings and Cautions

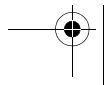
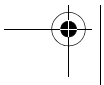
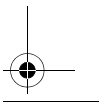
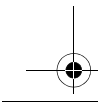

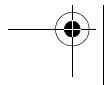
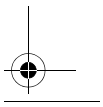
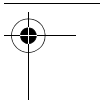
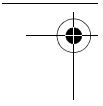
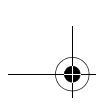
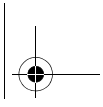



2 Introduction



PathFindIR - See More, Be Safer!

2.1 Overview

Congratulations! You have purchased one of the most sophisticated and important instruments you will have on your vehicle. The FLIR ThermoVision®PathFindIR is a state-of-the-art thermal imaging system that will provide you with excellent night visibility and situational awareness, even in absolute darkness.

The PathFindIR system is designed for simple, intuitive operation. The PathFindIR camera is a sophisticated thermal sensor that converts thermal content (heat) of a scene into a 2-dimensional image for display on a video monitor inside your vehicle.

2.2 Thermal Imaging Driver Vision Enhancement System

The FLIR Systems, Inc. PathFindIR camera is a high performance, rugged, thermal imaging camera designed to provide driver vision enhancement in adverse weather conditions and better situational awareness than with traditional head lamps.

Many serious accidents occur at night because the driver is not able to see the cause of the accident in time to prevent the collision. PathFindIR directly addresses this problem, allowing drivers to see farther ahead on nighttime roadways and identify potential problems earlier. The majority of trucking accidents occur in rural areas, where visibility is severely reduced at night. Humans and other warm blooded animals offer significant thermal contrast to driving backgrounds and are easy to spot with the PathFindIR. The system allows drivers to see without any additional lighting and provides real-time imaging at any speed.

Different than visible light cameras, thermal imagers do not display reflected light as seen with human eyes. Rather, thermal imaging cameras only 'see' temperature differences which are converted into shades of grey,

2 – Introduction

from black to white. The PathFindIR camera displays cold objects as black and hot objects as white.

When using a thermal imager in darkness, the image is created based on temperature differences of objects in the field of view, rather than reflected light from headlights.

Furthermore, because thermal imaging cameras only 'see' heat sources and not reflected light, they are ideal to assist with driver vision and situational awareness for oncoming obstructions such as animals, people, and other vehicles

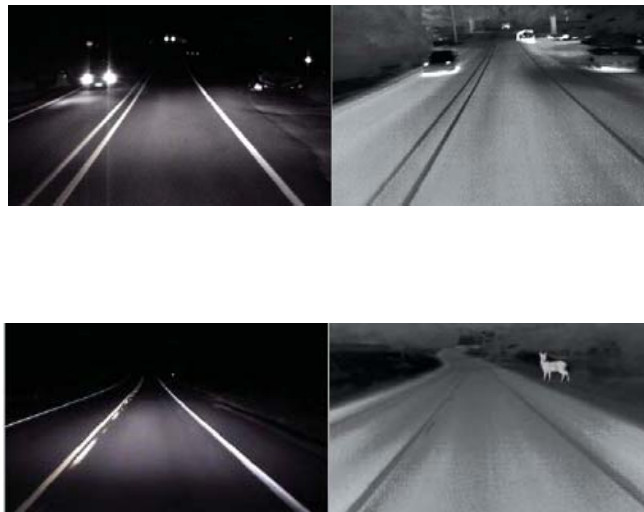

Figure 2-1: PathFindIR Makes the Difference

The above images show a comparison of typical night time driving compared to using the PathFindIR thermal imager. The image on the left is from an ordinary digital camera and shows the amount of visible light as illuminated by headlights; the image on the right is a thermal image created by the PathFindIR thermal imaging camera. Note the PathFindIR camera is sensitive to warm objects, such as the deer, and provides visibility over a much greater distance.



2 – Introduction



Some of the objects that are most critical for a driver to avoid are people and animals. Because these objects are naturally warm, they are particularly easy to see with the PathFindIR and clearly stand out in the video image.

Although adverse conditions such as heavy fog will affect any driver vision enhancement system, thermal imaging cameras such as the PathFindIR have been shown to continue to provide useful information in conditions of reduced visibility, such as haze and smoke. While the PathFindIR can assist drivers with detection of obstructions in the vehicle's path, thermal imagers should not be used as the sole vision method of the driver.

PathFindIR is specifically designed to withstand a harsh environment, with a hermetically-sealed external housing resistant to rocks, sand, salt, and under-hood contaminants. Additionally, the wide operating temperature range allows the PathFindIR to maintain high performance in severe weather conditions.

2.3 What is Thermal Imaging?

With our eyes, we see visible light. With a thermal imager, we can see infrared - a form of light just beyond the visible spectrum. Thermal imagers show subtle differences in temperature; warm objects appear white and cooler objects appear black.

In addition to driver vision enhancement, FLIR's thermal imaging cameras are used in a wide variety of applications, including fire fighting, security, maritime, industrial and medical applications. They continue to be used by militaries worldwide to navigate at night and in battlefield conditions. Over the last few years, volume production of these systems has allowed FLIR to offer the same high performance cameras designed for military use to the commercial market.

2.4 Vehicles that use PathFindIR

Passenger Vehicles, Commercial Trucks, Buses, and Recreational Vehicles - PathFindIR can increase the detection time for hazards and reduce the probability of an accident - saving lives, property, and profits.

2 – Introduction

Emergency Vehicles - Emergency vehicles' high speeds and degraded stopping distances increase the chance of an accident - PathFindIR improves hazard detection at high speeds.

Commuter and Freight Trains - PathFindIR can reveal railway obstructions at long ranges in complete darkness. This early detection capability can significantly increase reaction time depending on the size of the obstruction.

Heavy Construction Vehicles - For heavy equipment navigation, PathFindIR improves awareness in conditions that render eyesight and daylight cameras useless. The PathFindIR can see clearly through dust and smoke, increasing safety for everyone on the job site.

2.5 Parts List

PathFindIR Camera Unit Only

Model numbers:

- 334-0001-00 PathFindIR Unit 30Hz, NTSC
- 334-0001-00S PathFindIR Unit 7.5Hz, NTSC
- 334-0001-00P PathFindIR Unit 25Hz, PAL
- 334-0001-00PS PathFindIR Unit 8.3Hz, PAL



All thermal imaging systems are subject to export control. Standard NTSC (30Hz) and PAL (25Hz) units are subject to export restrictions and licensing by the United States Government. Models with video frame rates at or below 9Hz do not require licensing but do require compliance with other export requirements. Please contact FLIR for details concerning export compliance for your application or geographic area.



3 Getting Started



The thermal imaging camera inside the PathFindIR is completely sealed and extremely rugged. The camera has been qualified for operation in all types of weather conditions over the specified operating temperature range and includes an automatic window heater that will prevent icing under most conditions.

3.1 Using your PathFindIR

The PathFindIR is easy to use, but you should take a moment to carefully read this section so you fully understand what you are seeing on your display. While the imagery you will see on the monitor may look like black and white daylight video, it isn't! A few tips on how to interpret some of the imagery will help you to make the most of your system.

The camera automatically adjusts to changing scene conditions so no additional camera control is necessary. Scenes with familiar objects will be easy to interpret with some experience. The camera automatically optimizes the image to provide you with the best contrast in most conditions.

The thermal imager inside the camera does not sense light like conventional cameras; it senses heat or temperature differences. As you experiment with the system during nighttime operation, you will notice variances in the “picture quality”; this is normal. The camera senses small “differences” in apparent radiation from the objects in view, and displays them as either white (or lighter shades of gray) for warmer objects, and black (or darker shades of gray) for colder objects.

3.2 Initial System Startup

The PathFindIR camera requires power and a connection to an external monitor to provide imagery. Make sure to test the system prior to installation to assure the system is functioning properly. Be sure to remove the protective window sticker prior to test and installation.

Upon initial power up you will hear a slight clicking sound. This click is the internal image correction. This noise is the mechanical shutter assembly which will cause the image to momentarily “freeze.” This noise and image freezing will occur until the unit has reached a thermally stable

3 – Getting Started

temperature and periodically thereafter. See “Automatic Shutter” on page 10.

3.3 Heater Element

The PathFindIR has a built-in heating element to stabilize the window and prevent ice build-up in cold weather conditions. The heating element is automatically turned on when the temperature of the window falls below 4°C and is turned off when the temperature reaches 6°C.

3.4 Automatic Shutter

The PathFindIR incorporates an automatic image correction feature via the internal calibration shutter. This shutter will activate every 2 minutes or more frequently during initial start up and large environmental temperature changes. During this function the image will be “frozen” for approximately half a second.

The frozen image will display a small white box in the left middle portion of the image during this calibration, as shown in the image below.



3.5 In Case of Difficulty

The PathFindIR comes with a 12 month limited warranty from the date of purchase. DO NOT OPEN, MODIFY, or ALTER the PathFindIR unit or accessories. Doing so will void any warranty and may cause system malfunction, loss of performance, fire, or bodily harm.



3 – Getting Started



The PathFindIR is a highly sophisticated electronic imaging system. Should the system fail for any reason do not attempt to fix the system or wiring cables yourself. Check wiring connections, power input, video output. If system is not performing please contact the manufacture at +1.888.747.3547 or +1.805.964.9797 and ask to speak to the service department. You will need the serial number of the unit to obtain a Return Material Authorization.

3.6 Troubleshooting

No Video but the system is running and has power supplied to it.

Place your ear next to the PathFindIR unit. If you hear the mechanical shutter (clicking noise, see section 3.2 “Initial System Startup” on page 9) but you are not getting an image, check the video connections. The PathFindIR works with most standard NTSC or PAL monitors that have 75 ohm input.

No Video, no clicking.

If video is not displayed and you do not hear a "clicking" sound from the PathFindIR, check the power inputs. The PathFindIR runs on 6V to 16V power through the optional 20 foot standard cable power leads. If this voltage is exceeded the unit will not function and may be damaged.

The image is cloudy or hazy, or the window has fog or ice built up.

The PathFindIR is equipped with an automatic heating element which turns on at cold temperatures. The heater requires a few moments to stabilize the window. Once the window is thermally stabilized the heating element will turn off automatically.

The image has "lines" or screen door appearance.

Check to see if the image "freezes" or if you hear a mechanical "clicking noise" from the PathFindIR unit. If you do not see the image freeze momentarily (this may take a few minutes), the internal shutter may be damaged. Contact the manufacturer.

3

3 – Getting Started

The image is shaky.

Check your mounting. The PathFindIR does not incorporate image stabilization and must be mounted soundly and securely.

Image is dim.

Check your monitor and video connections. It is recommended that you use separate power supplies for the PathFindIR and the local display to make sure you have clean uninterrupted power. Also, verify the PathFindIR is connected to the 75 ohm input on the monitor. The image may be dim if the camera is connected to an input that requires a different impedance.

The image is dark and no objects are seen.

Recycle the power and see if you get the "Splash Screen" (as seen below) on the display. If you get the Splash Screen but no image afterwards (only a black screen), check to make sure that the window is clear of all obstructions (refer to the maintenance section for information on window cleaning). If you do not see the Splash Screen, check the power input and video output.

If you see the Splash Screen but no image afterwards, it is possible the mechanical shutter is stuck in the on position. Contact FLIR customer service for additional help.



Figure 3-1: Startup Splash Screen



4 Caring for your PathFindIR



4.1 Product Cleaning

Caution! Do not open the camera body for any reason. Disassembly of the camera (including removal of the cover) can cause permanent damage and will void the warranty.

Your PathFindIR camera images through an infrared transparent window. This window is designed for the harsh automotive environment of normal driving, but may require occasional cleaning. FLIR Systems Inc. suggests that you clean the window of the PathFindIR when image quality degradation is noticed or excessive contaminant build-up is seen on the window.

The camera housing has a durable coating and the rugged protective window is designed to withstand normal cleaning. Rinse the camera housing with low pressure fresh water to keep it clean. If the front window of the PathFindIR gets water spots, wipe it with a clean soft cotton cloth dampened with fresh water. If the window requires further cleaning, use a soft moist cotton-based cloth with isopropyl alcohol or dish soap.

Do not use abrasive materials, such as paper or scrub brushes as this will possibly damage the window by scratching it. Only clean the window when you can visually see contamination on the surface.

4

4.2 Temperature

The PathFindIR camera has an operating temperature range of -40 to 80°C. Choose an installation location so that the PathFindIR is not subject to temperature extremes that exceed this range.

4.3 Maintenance

If you have problems do not attempt to repair the PathFindIR unit yourself. The PathFindIR camera is a water-tight sealed unit and can not be opened

4 – Caring for your PathFindLR

or serviced in the field. Consult your installation dealer or FLIR Systems Inc. for repair information.

If the camera will not produce an image, check the video connection at the camera and at your display. If the connectors appear to be properly engaged but the camera still does not produce an image, have an authorized service representative make the appropriate repairs.

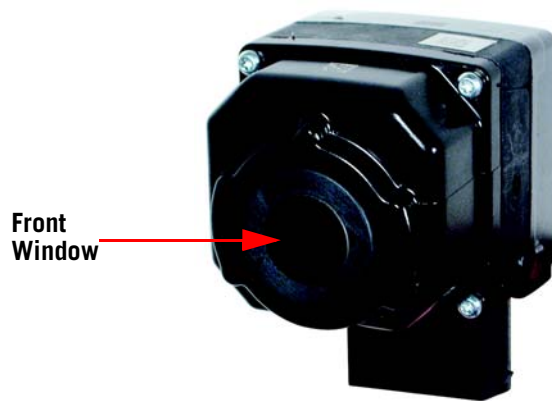

Figure 4-1: Front Window

Caution! Improper care of the camera window can cause damage to the anti-reflective coating, degrade the camera's performance, and void the camera warranty.

5 Options and Accessories

5.1 Accessories

Camera options and accessories are subject to change. Refer to the FLIR web site <http://www.flir.com> or contact your local dealer to obtain up-to-date information regarding available accessories such as mounting kits, monitor options, cables and accessories.

5.1.1 PathFindIR Interface Cable

Part Number: 308-0121-00

The standard 20 foot system cable ensures a sealed connection to the PathFindIR, a requirement for harsh vehicle environments. Cable includes sealed PathFindIR connector at one end and two open power leads and a BNC video connection at the other end.

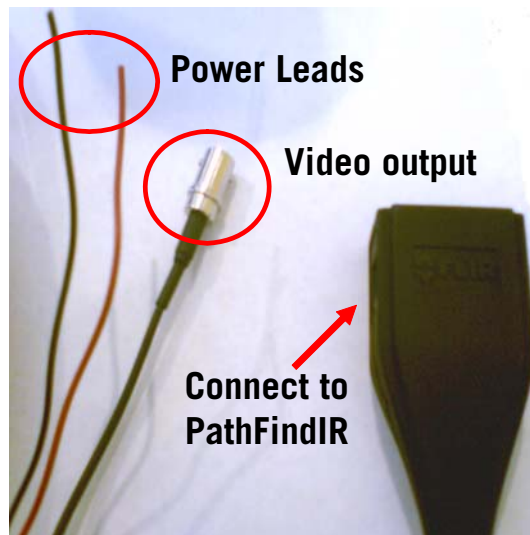

5 – Options and Accessories

5.1.2 Aftermarket Installation Kit

The FLIR Aftermarket Installation Kit, part number 421-0029-00, is made available to facilitate installation in most vehicle applications and includes a video monitor, cables, and mounting hardware. The kit contains:

- Universal Mounting Bracket and hardware
- PathFindIR Interface Cable 308-0121-00
- Safety Vision 7" Monitor with Mounting Bracket and Sun Shield
- Monitor Interface Cable SV-513

The kit will work with any PathFindIR camera, which must be purchased separately. The following diagram shows how to connect the PathFindIR using the cables in the Aftermarket Installation Kit.

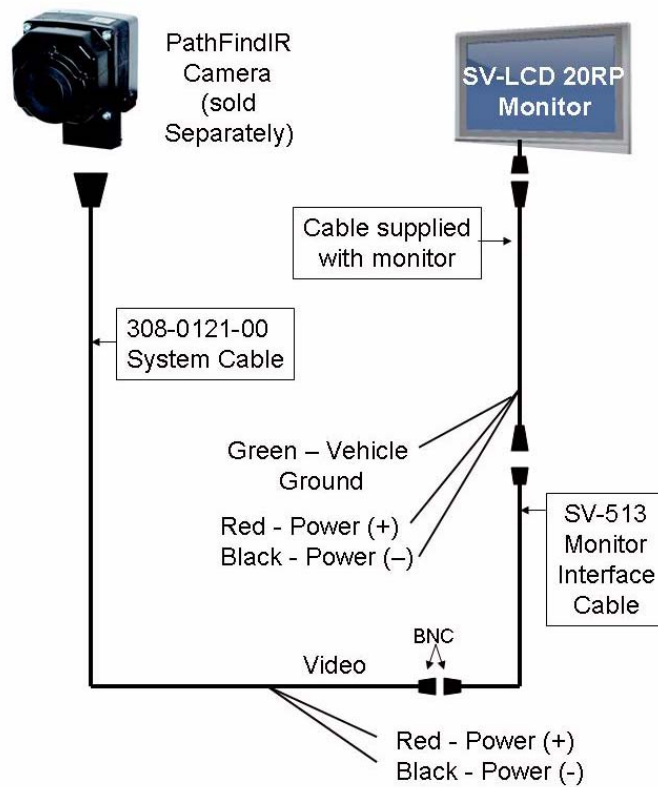



5.1.3 Bench Top Kit

The optional FLIR Bench Top Kit, part number 421-0027-00, is made available for those who want to operate the PathFindIR from a 110/240VAC power source, for lab testing or for applications where standard household power is available. The kit contains:

- Bench Top Mounting Bracket
- PathFindIR Bench Top Cable 308-0142-00
- 110/240VAC to 9VDC power supply and line cord

The kit will work with any PathFindIR camera, which must be purchased separately. The following diagram shows how to connect the PathFindIR using the cables in the Bench Top Kit.

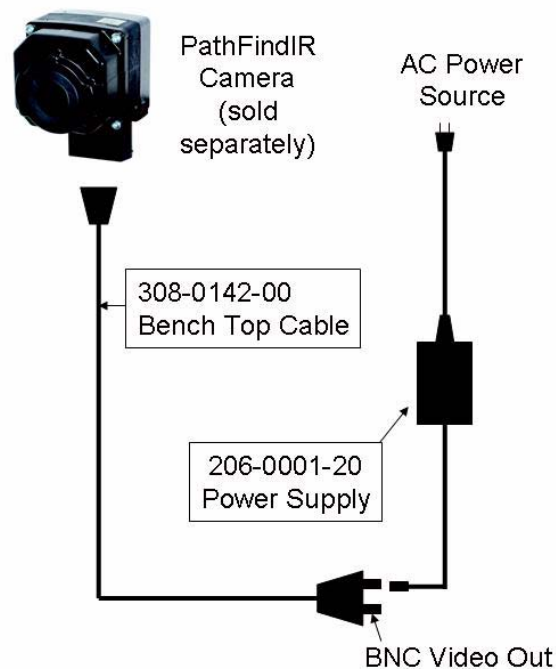

Please contact FLIR or your local dealer/installer for the latest information on PathFindIR accessories.

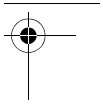
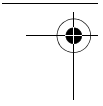
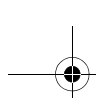
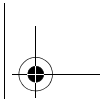

5 - Options and Accessories

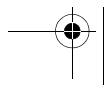
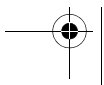
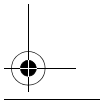
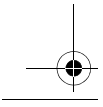

6 Technical Data

6.1 Performance Specification

Thermal Imaging Performance

Sensor type	Uncooled microbolometer
Field of view	36° h x 27° v
Spectral band	8 - 14 μ
Resolution	320 x 240 pixels
Time to Image	< 2 sec.
Focal Length	19 millimeters

Outputs

Video	NTSC or PAL
Connector types	12-pin automotive connector for power in, video out
Frame Rate	30-Hz for NTSC Video, 25 Hz for PAL video
Note: Hz is equivalent to frames per second	< 9 Hz Export Compliant

Power

Power requirements	12 Vdc nominal (range 6V to 16V)
Power consumption	2 Watts (nominal) 8 Watts with heater turned on

Environmental

Operating temperature	-40° C to +80°C
Impact protection	High-impact resistant window with heating element
Weather Resistance	Hermetically sealed, pressurized enclosure For additional information, contact FLIR.

Dimensions and Weight

Dimensions (Width x Height x Length)	58mm x 57mm x 72mm (2.3" x 2.2" x 2.8") excluding connector Connector adds 25.7 mm to height
Weight	less than 0.4 kg (0.88 lb.)
Mounting Points	2 per side, M4x0.7 6mm screws required

6

6 – Technical Data

6.1.1 Side View

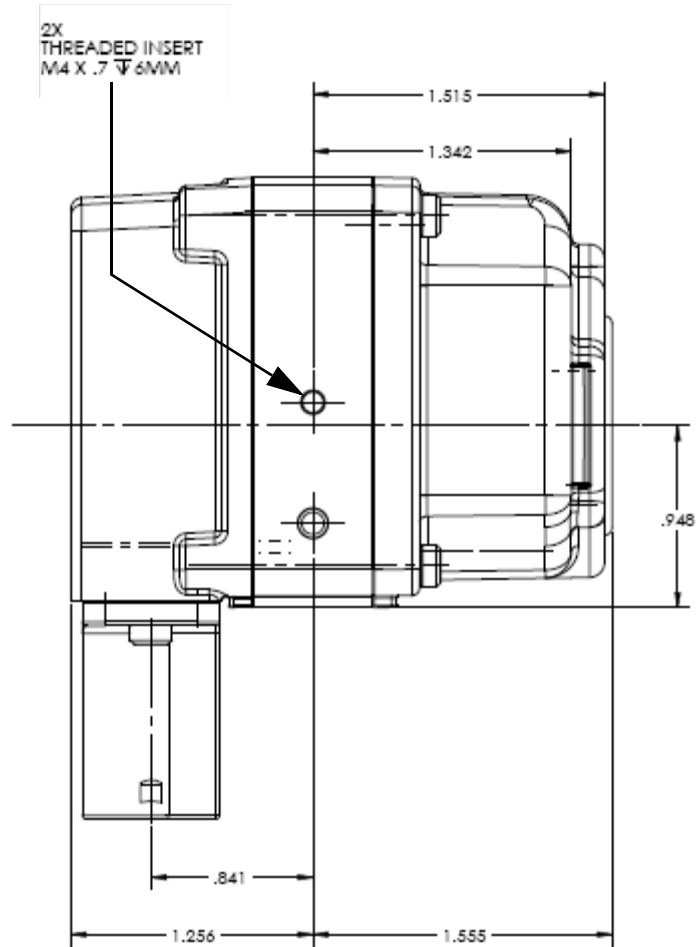

6 – Technical Data

6.1.2 Side View, Additional Dimensions

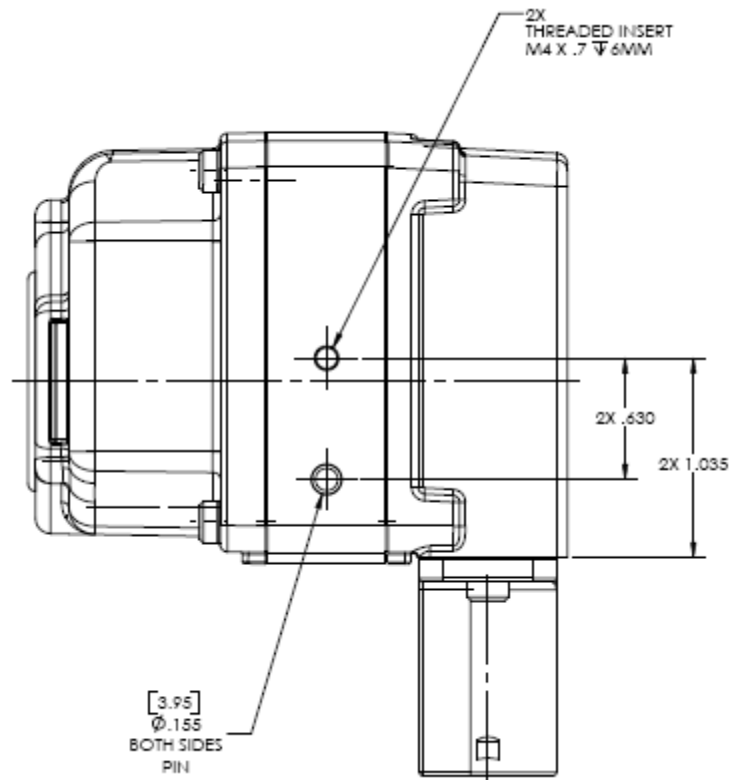

6

6 – Technical Data

6.1.3 Front View

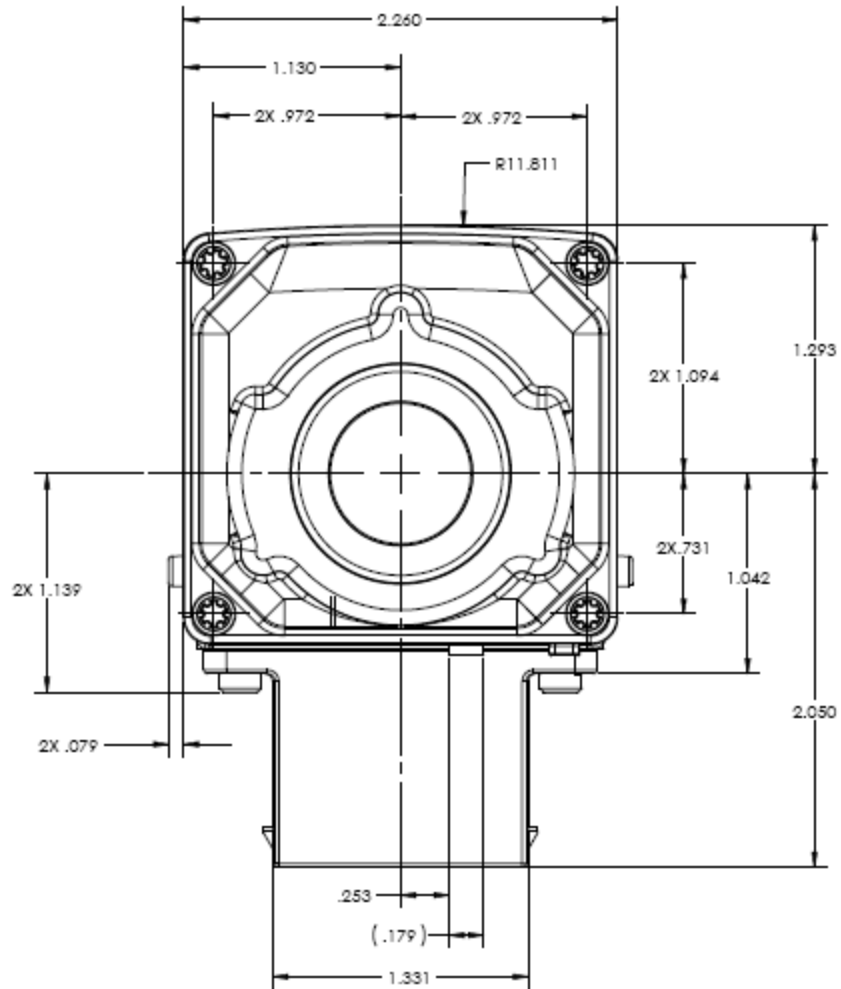

7 Installation

7.1 PathFindIR Installation

The PathFindIR is a compact, sealed imaging system that fits easily behind vehicle grilles and in other compact locations. It includes an internal heater to keep the lens clear in icy conditions, and delivers superior image quality. It can be ordered as a camera module with a commercial grade cable.

The PathFindIR must be mounted in a location where it is not obstructed by the windshield or other glass materials. Although glass is transparent to the human eye, it is opaque in the infrared spectrum.

The PathFindIR should be installed by an installer or dealer trained by FLIR Systems, Inc. If one is not available in your area we recommend that you use a reputable car audio/video installation shop that specializes in mobile video system integration. The wiring and installation requires special care and integration techniques. Improper installation may result in damage to the camera and may void the warranty.

Some modifications to the vehicle's exterior may be required, as well as integration into various display units, including factory LCD or aftermarket multi-functional display units.

7.2 Preparation

The PathFindIR Standard 20 foot system cable has two open power leads to be connected to a power source operating between 6V - 16V. The standard cable accessory also includes a BNC male end. Refer to the model number for your specific analog video output format.

It is recommended that power to the monitor be supplied separately from power to the PathFindIR unit to assure clean (low noise) power to both items. Otherwise the video image may appear to have interference, ghosting, or undesirable video artifacts.

Caution: Before wiring the camera, disconnect all power from the battery. Failure to do so may result in shock, bodily harm, or damage to system.



7 – Installation

7.3 Installation

Installation using incorrect connections may result in system malfunction or risk of shock. FLIR Systems, Inc. recommends the standard 20-foot cable for proper installation (refer to Chapter 5.1 “Accessories” on page 5-15). This cable is sealed and provides two power input leads and video output via the connected BNC adapter.

The proper mating connector must be used when installing the PathFindIR. The use of other connectors may result in damage to the camera that is not covered by the limited product warranty.

The Standard 20 foot System cable has a BNC connector for video output. You may need to purchase connectors/converters to connect to aftermarket or factory-installed video monitors.

Caution: Supplying power to the unit outside of the recommended and stated values will result in system malfunction and void the warranty. This may also result in excessive heat build up, shock, or fire.

7.4 Installation Guidelines and Precautions

Do not splice cables or tap into existing cables for power or video. Doing so may result in shock, fire, or damage to electrical system/equipment. Power connections should be made to the fused side of the vehicle's power distribution block.

Do not install in areas where the unit will hinder vehicle operation, i.e. radiator, steering, head lamps, braking systems. Doing so may interfere with the vehicle's operation and cause an accident.

Do not install in areas of high moisture, dust or air intake paths. Doing so may hinder the performance of the PathFindIR unit and cause image degradation or window damage.

Use only authorized parts and accessories. Doing so helps assure proper mounting and connectivity and limits external issues associated with poorly secured mounting and wiring.



7 – Installation



Disconnect the negative (-) battery terminal prior to installation.

Connect the unit to the vehicle power distribution block using an available fused (2 amp) connection. Be sure to connect each lead to the correct polarity (red-positive and black-negative).

Be sure to securely mount the system to assure reliable connections and stable system performance.

Record the serial number, date of purchase, location of purchase and keep in a safe place.

When making connections to the vehicle's electrical system be aware of the vehicle's installed components (i.e. on board computer system).

Do not mount a display where it will distract the driver or adversely affect the driver's vision.

7.5 Installation Assistance

FLIR offers the Aftermarket Installation Kit which is suitable for many applications. Refer to Chapter 5.1.2 "Other Accessories" on page 5-16 for more information about installing the camera with the kit.

If your company has applications utilizing a large number of PathFindIRs on a specific vehicle please contact FLIR Systems, Inc. directly to discuss your needs.

7.6 Mounting Assistance

The following are some general guidelines which will assist your professional service and installer with good mounting positions and connections.

The PathFindIR is a thermal imaging system. As such, it will not "see through" windows or obstructions. The system should be mounted outside the vehicle's cabin (interior) and in such a location to assure a similar driving viewing field of view as normal head lamps and human vision.



7



7 – Installation



FLIR Systems Inc. is not liable for any modifications made to the vehicle's body, or aftermarket parts. Owner assumes all risk when modifying vehicles body, frame, grill, or any other structure. Care should be taken when drilling or cutting into parts. Contact your vehicle manufacture to assure that the mounting location does not affect the performance, operation, or safety features of your vehicle.

Mounting should be performed by a FLIR-authorized service center or professional installer of automotive aftermarket equipment. Many shops familiar with rear vision cameras will be able to assist in the mounting and location of the PathFindIR system, as well as proper display mounting and integration.

Caution: Contact your vehicle manufacture to assure that your mounting location does not affect any sensors found in bumpers or grills (such as air bag deployment devices). Mounting the PathFindIR should never interfere with the mechanical or electrical components or airways to maintain vehicle performance or operations.

8 Infrared Technology

8.1 History of Infrared

Less than 200 years ago the existence of the infrared portion of the electromagnetic spectrum wasn't even suspected. The original significance of the infrared spectrum, or simply 'the infrared' as it is often called, as a form of heat radiation is perhaps less obvious today than it was at the time of its discovery by Herschel in 1800.



Figure 8-1: Sir William Herschel (1738–1822)

The discovery was made accidentally during the search for a new optical material. Sir William Herschel—Royal Astronomer to King George III of England, and already famous for his discovery of the planet Uranus—was searching for an optical filter material to reduce the brightness of the sun's image in telescopes during solar observations. While testing different samples of colored glass which gave similar reductions in brightness he was intrigued to find that some of the samples passed very little of the sun's heat, while others passed so much heat that he risked eye damage after only a few seconds' observation.

Herschel was soon convinced of the necessity of setting up a systematic experiment, with the objective of finding a single material that would give the desired reduction in brightness as well as the maximum reduction in heat. He began the experiment by actually repeating Newton's prism experiment, but looking for the heating effect rather than the visual distribution of intensity in the spectrum. He first blackened the bulb of a sensitive mercury-in-glass thermometer with ink, and with this as his radiation detector he proceeded to test the heating effect of the various colors of the spectrum formed on the top of a table by passing sunlight through a glass prism. Other thermometers, placed outside the sun's rays, served as controls.

8 – Infrared Technology

As the blackened thermometer was moved slowly along the colors of the spectrum, the temperature readings showed a steady increase from the violet end to the red end. This was not entirely unexpected, since the Italian researcher, Landriani, in a similar experiment in 1777 had observed much the same effect. It was Herschel, however, who was the first to recognize that there must be a point where the heating effect reaches a maximum, and those measurements confined to the visible portion of the spectrum failed to locate this point.



Figure 8-2: Marsilio Landriani (1746–1815)

Moving the thermometer into the dark region beyond the red end of the spectrum, Herschel confirmed that the heating continued to increase. The maximum point, when he found it, lay well beyond the red end—in what is known today as the ‘infrared wavelengths’.

When Herschel revealed his discovery, he referred to this new portion of the electromagnetic spectrum as the ‘thermometrical spectrum’. The radiation itself he sometimes referred to as ‘dark heat’, or simply ‘the invisible rays’. Ironically, and contrary to popular opinion, it wasn't Herschel who originated the term ‘infrared’. The word only began to appear in print around 75 years later, and it is still unclear who should receive credit as the originator.

Herschel's use of glass in the prism of his original experiment led to some early controversies with his contemporaries about the actual existence of the infrared wavelengths. Different investigators, in attempting to confirm his work, used various types of glass indiscriminately, having different transparencies in the infrared. Through his later experiments, Herschel was aware of the limited transparency of glass to the newly-discovered thermal radiation, and he was forced to conclude that optics for the infrared would probably be doomed to the use of reflective elements exclusively (i.e. plane and curved mirrors). Fortunately, this proved to be

8 – Infrared Technology

true only until 1830, when the Italian investigator, Melloni, made his great discovery that naturally occurring rock salt (NaCl)—which was available in large enough natural crystals to be made into lenses and prisms—is remarkably transparent to the infrared. The result was that rock salt became the principal infrared optical material, and remained so for the next hundred years, until the art of synthetic crystal growing was mastered in the 1930's.



Figure 8-3: Macedonio Melloni (1798–1854)

Thermometers, as radiation detectors, remained unchallenged until 1829, the year Nobili invented the thermocouple. (Herschel's own thermometer could be read to 0.2 °C (0.036 °F), and later models were able to be read to 0.05 °C (0.09 °F)). Then a breakthrough occurred; Melloni connected a number of thermocouples in series to form the first thermopile. The new device was at least 40 times as sensitive as the best thermometer of the day for detecting heat radiation—capable of detecting the heat from a person standing three meters away.

The first so-called 'heat-picture' became possible in 1840, the result of work by Sir John Herschel, son of the discoverer of the infrared and a famous astronomer in his own right. Based upon the differential evaporation of a thin film of oil when exposed to a heat pattern focused upon it, the thermal image could be seen by reflected light where the interference effects of the oil film made the image visible to the eye. Sir John also managed to obtain a primitive record of the thermal image on paper, which he called a 'thermograph'.

8 – Infrared Technology



Figure 8-4: Samuel P. Langley (1834–1906)

The improvement of infrared-detector sensitivity progressed slowly. Another major breakthrough, made by Langley in 1880, was the invention of the bolometer. This consisted of a thin blackened strip of platinum connected in one arm of a Wheatstone bridge circuit upon which the infrared radiation was focused and to which a sensitive galvanometer responded. This instrument is said to have been able to detect the heat from a cow at a distance of 400 meters.

An English scientist, Sir James Dewar, first introduced the use of liquefied gases as cooling agents (such as liquid nitrogen with a temperature of $-196\text{ }^{\circ}\text{C}$ ($-320.8\text{ }^{\circ}\text{F}$)) in low temperature research. In 1892 he invented a unique vacuum insulating container in which it is possible to store liquefied gases for entire days. The common ‘thermos bottle’, used for storing hot and cold drinks, is based upon his invention.

Between the years 1900 and 1920, the inventors of the world ‘discovered’ the infrared. Many patents were issued for devices to detect personnel, artillery, aircraft, ships—and even icebergs. The first operating systems, in the modern sense, began to be developed during the 1914–18 war, when both sides had research programs devoted to the military exploitation of the infrared. These programs included experimental systems for enemy intrusion/detection, remote temperature sensing, secure communications, and ‘flying torpedo’ guidance. An infrared search system tested during this period was able to detect an approaching airplane at a distance of 1.5 km (0.94 miles), or a person more than 300 meters (984 ft.) away.

The most sensitive systems up to this time were all based upon variations of the bolometer idea, but the period between the two wars saw the development of two revolutionary new infrared detectors: the image



8 – Infrared Technology



converter and the photon detector. At first, the image converter received the greatest attention by the military, because it enabled an observer for the first time in history to literally 'see in the dark'. However, the sensitivity of the image converter was limited to the near infrared wavelengths, and the most interesting military targets (i.e. enemy soldiers) had to be illuminated by infrared search beams. Since this involved the risk of giving away the observer's position to a similarly-equipped enemy observer, it is understandable that military interest in the image converter eventually faded.

The tactical military disadvantages of so-called 'active' (i.e. search beam-equipped) thermal imaging systems provided impetus following the 1939–45 war for extensive secret military infrared-research programs into the possibilities of developing 'passive' (no search beam) systems around the extremely sensitive photon detector. During this period, military secrecy regulations completely prevented disclosure of the status of infrared-imaging technology. This secrecy only began to be lifted in the middle of the 1950's, and from that time adequate thermal-imaging devices finally began to be available to civilian science and industry.

8.2 How do Infrared Cameras Work?

Infrared energy is part of a complete range of radiation called the electromagnetic spectrum. The electromagnetic spectrum includes gamma rays, X-rays, ultraviolet, visible, infrared, microwaves (RADAR), and radio waves. The only difference between these different types of radiation is their wavelength or frequency. All of these forms of radiation travel at the speed of light (186,000 miles or 300,000,000 meters per second in a vacuum). Infrared radiation lies between the visible and RADAR portions of the electromagnetic spectrum. Thus infrared waves have wavelengths longer than visible and shorter than RADAR.

8 – Infrared Technology

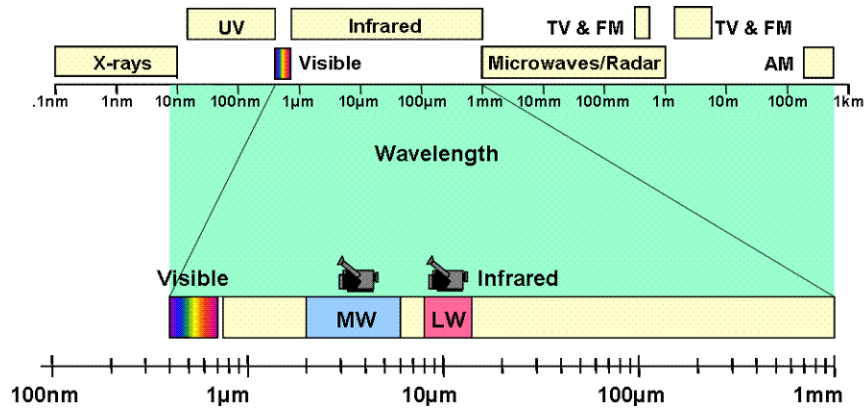

Figure 8-5: Electromagnetic Spectrum

The primary source of infrared radiation is heat or thermal radiation. Any object which has a temperature radiates in the infrared portion of the electromagnetic spectrum. Even objects that are very cold, such as an ice cube, emit infrared. When an object is not quite hot enough to radiate visible light, it will emit most of its energy in the infrared. For example, hot charcoal may not give off light, but it does emit infrared radiation which we feel as heat. The warmer the object, the more infrared radiation it emits.

Infrared cameras produce an image of invisible infrared or “heat” radiation that is unseen by the human eye. There are no colors or “shades” of gray in infrared, only varying intensities of radiated energy. The infrared imager converts this energy into an image that we can interpret. Several detector technologies exist; the sensor in the PathFindIR is of the latest solid state design, offering long life and fully automatic image optimization (contrast and gain). True thermal imagers should not be confused with infrared illuminator cameras that are often presented as simply “infrared cameras.” There are hundreds of low cost infrared illuminated cameras on the market at prices below \$100. These cameras do not produce the same image because they do not detect heat. They operate in wavelengths near visible, and require an IR illuminator to provide an image. IR illuminators have very short range, and require a lot of power to see beyond 5 meters.

Santa Barbara	Portland
<p><i>CVS World Headquarters</i> FLIR Systems, Inc. 70 Castilian Dr. Goleta, CA 93117 USA PH: +1.888.747.FLIR (+1.888.747.3547)</p>	<p><i>FLIR Corporate Headquarters</i> FLIR Systems, Inc. 27700A SW Parkway Ave. Wilsonville, OR 97070 USA</p>
Netherlands	
<p><i>CVS Eurasian Headquarters</i> FLIR Commercial Vision Systems B.V. Charles Petitweg 21 4847 NW Teteringen - Breda The Netherlands</p>	

